

Montageanleitung • Assembly Instructions • Notice de montage

Standregale • Shelving Systems • Rayonnage Standard

NORM(E) 28

Kreuzstrebe • Crossbrace • Croisillon

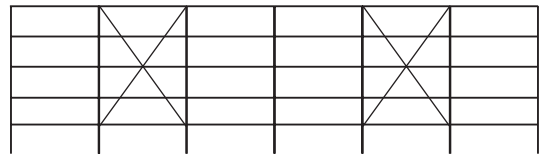
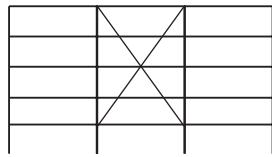
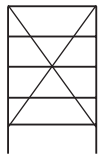
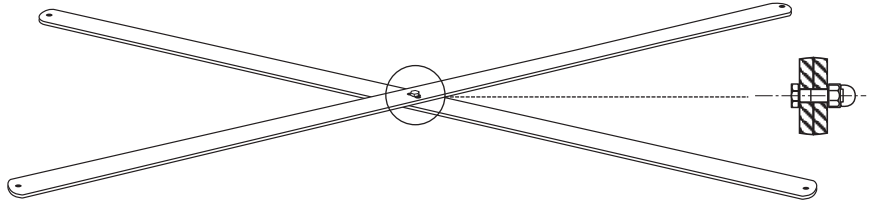
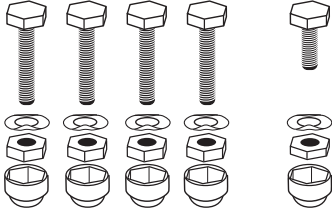

Montage • Assembly • Montage

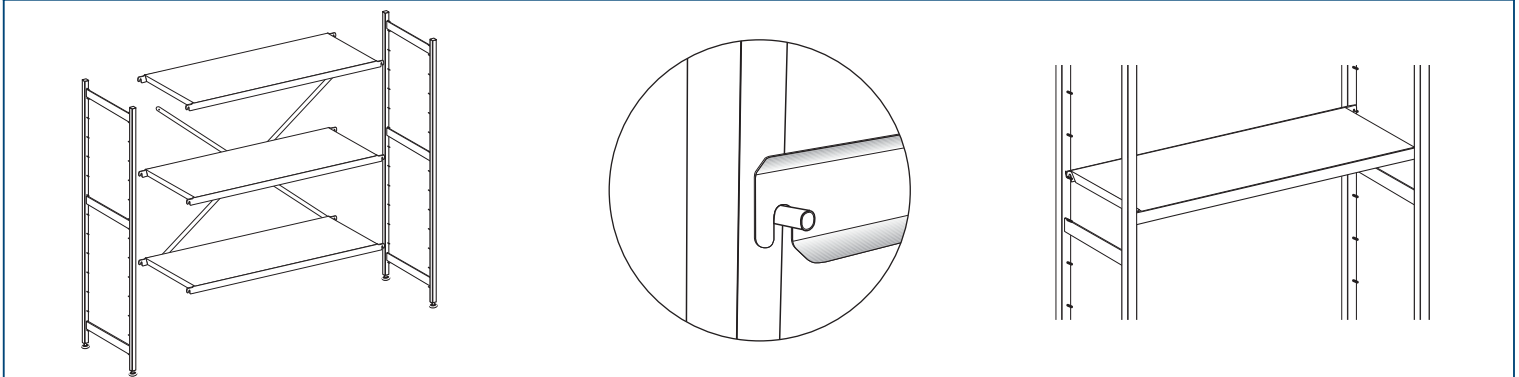
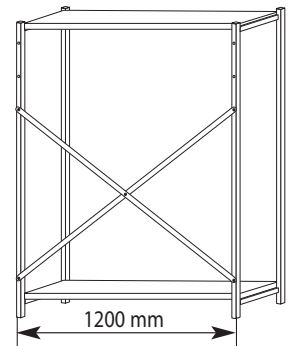
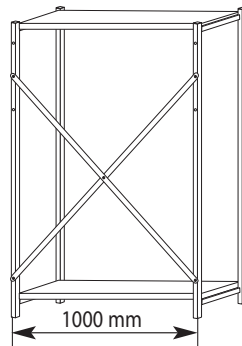
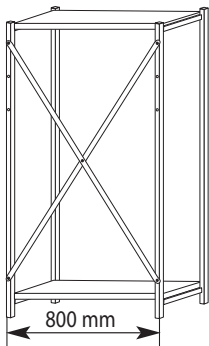
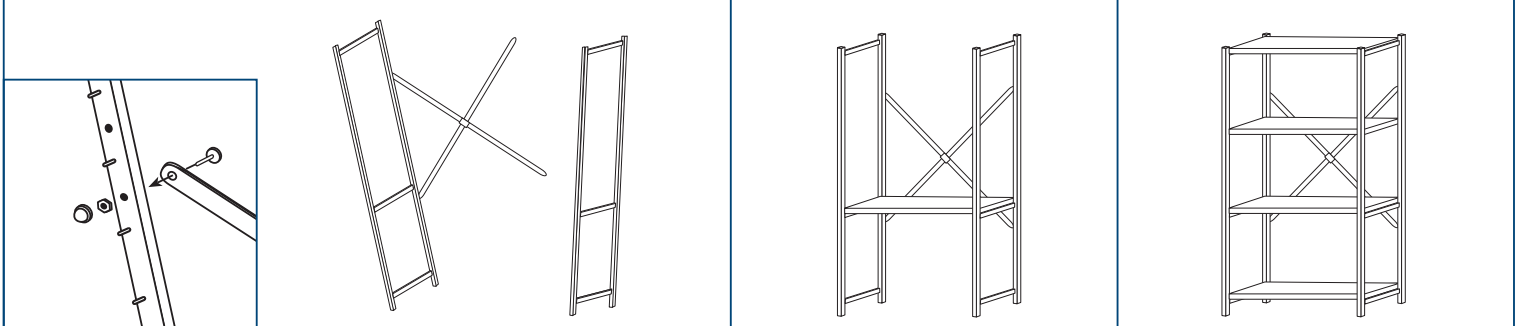

Lasten und Prüfzeichen • Loads and certification marks • Charges et marques de conformité

Feldlast • section load • charge per champ	Norm(e) 28
600 kg	

Eckbau • Shelf hooks • Montage en Angle

Geschlossene Auflagen • solid shelves • tablettes pleines

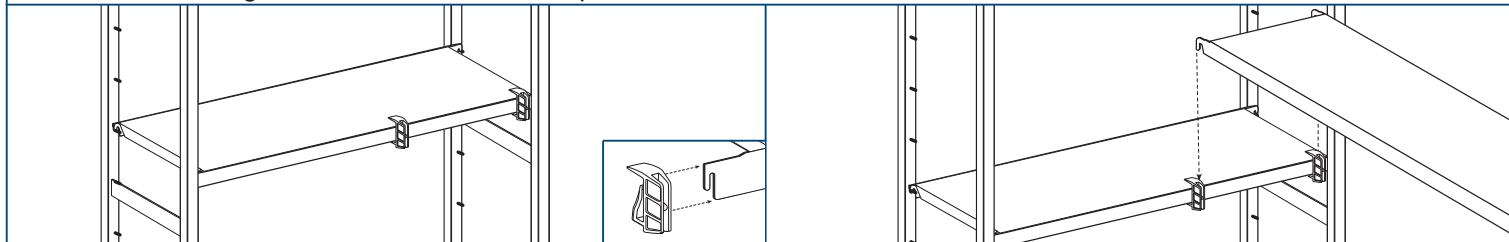

Geschlossene Kunststoff-Auflagen • solid polymer shelves • tablettes pleines en polystyrol

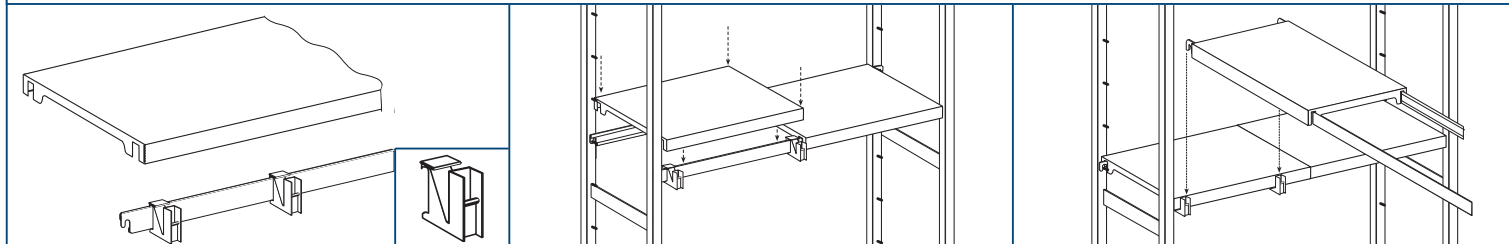

Kunststoffroste • polymer louvred shelves • tablettes ajourées en polystyrol

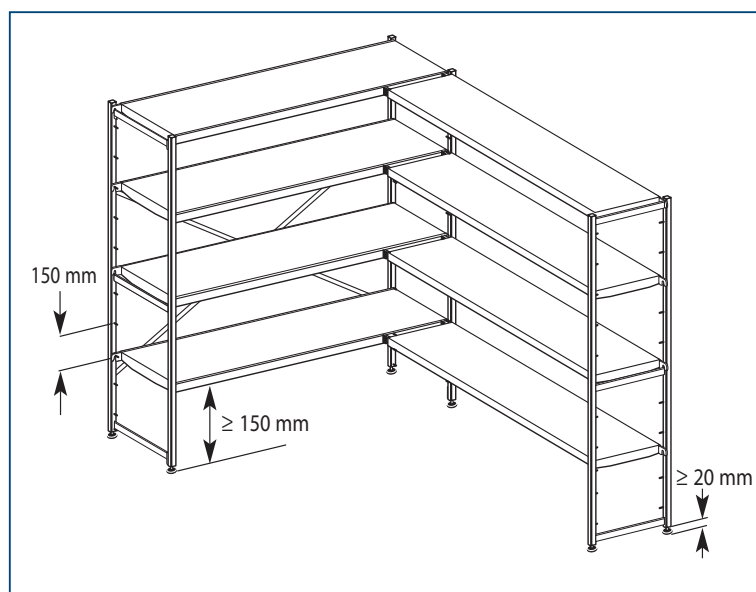
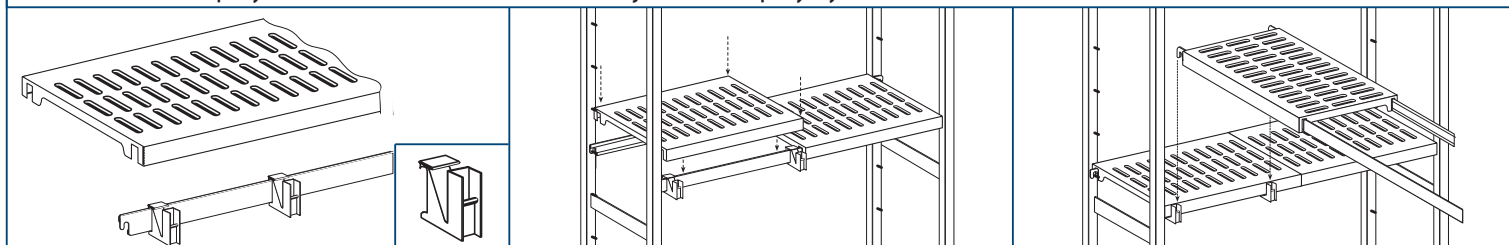

Reinigungshinweise • cleaning instructions • indications de nettoyage

Abrasive und chlorhaltige Reinigungsmittel sind nicht erlaubt. Die Regale sind regelmäßig mit einem feuchten Lappen abzuwischen. Das unterste Bord muß mindestens 150 mm Bodenfreiheit gewährleisten. Abrasive and corrosive agents are not allowed. The shelvings must be cleaned regularly with a damp cloth. The minimum distance between the floor and the lowest shelf is 150 mm. Produits lessiviels à exclure (produits chlorés et abrasifs). À nettoyer périodiquement avec port de gants. Le premier niveau doit être à 150 mm minimum du sol.

Viessmann Kältetechnik AG
Schleizer Straße 100
95030 Hof/Saale
Germany

Telefon 0 92 81/ 81 4-0
Telefax 0 92 81/ 81 4-2 69

info@vkag.de
www.vkag.de